



Muscadine Grape
Production Guide
for the Southeast

NC STATE

EXTENSION

Muscadine Grape Production Guide for the Southeast

Authors:

Mark Hoffmann

Small Fruits Extension Specialist
North Carolina State University, Department of
Horticultural Science

Patrick Conner

Professor, Muscadine Breeding Program
University of Georgia, Department of
Horticulture, Institute of Plant Breeding,
Genetics and Genomics (IPBGG)

Phillip Brannen

Extension Fruit Disease Specialist
University of Georgia, Department of Plant
Pathology

Hannah Burrack

Extension Specialist for Berry Insect Pests
North Carolina State University, Department of
Entomology and Plant Pathology

Wayne Mitchem

Fruit Weed Management Specialist
North Carolina State University, Department of
Horticultural Science

Bill Cline

Muscadine Pathology Specialist
North Carolina State University, Department of
Entomology and Plant Pathology

Penny Perkins-Veazie

Professor of Fruit Quality and Nutritional Value
North Carolina State University, Department of
Horticultural Science

Barclay Poling

Retired Muscadines Extension Specialist
North Carolina State University, Department of
Horticultural Science

Editors:

Editor in Chief:

Mark Hoffmann

Small Fruits Extension Specialist
North Carolina State University, Department of
Horticultural Science

Co-Editors:

Cain Hickey

Viticulture Extension Specialist
University of Georgia Department of
Horticulture

Hannah Burrack

Extension Specialist for Berry Insect Pests
North Carolina State University, Department of
Entomology and Plant Pathology

Grower Editorial Board:

Ervin Lineberger, Killdeer Farms, Kings
Mountain, North Carolina

William Yost, Cauble Creek Vineyards,
Salisbury, North Carolina

Whit Jones, Cottle Farms, Faison, North
Carolina

Summary

This guide is based on the Muscadine Grape Production Guide for North Carolina (Poling et al. 2003). It is designed to support commercial muscadine grape production operations in the Southeast with updated information on the successful and sustainable establishment and maintenance of muscadine vineyards. The muscadine industry has evolved into a multimillion-dollar industry in the United States over the past few decades. Muscadine grape production in the Southeast has been steadily increasing in acreage since 2003 due to increased demand for muscadine products; the market for muscadines and muscadine products has also diversified. In 2019, an estimated 3,000 acres of muscadines grapes were commercially grown in North Carolina, South Carolina, Georgia, and Florida alone, with two major markets: (a) processing into wine, jam, or juice, and (b) fresh market. Those two types of muscadine grape production models require different muscadine cultivars, business approaches, and marketing strategies. This production guide specifically refers to this development by providing cost-return estimates, overviews of common muscadine cultivars, vineyard establishment and management strategies, and background information for muscadine growers in North Carolina, South Carolina, and Georgia.

Contents

1. The Biology of the Wild Muscadine Grape (<i>Vitis rotundifolia</i> Michx.)	1
2. Modern Muscadine Cultivars	2
3. Costs and Estimated Returns.....	5
4. Main Production Regions in North Carolina, South Carolina, and Georgia	7
5. Climate Change and Muscadine Production.....	8
6. Propagation	9
7. Site Selection and Vineyard Establishment	10
8. Trellis and Planting.....	12
9. Training and Pruning	15
10. Canopy Management	18
11. Liming, Nutrient, and Fertilizer Management ..	18
12. Weed Management and Herbicide Injury	20
13. Insect Management.....	21
14. Disease Management.....	23
15. Harvesting.....	25
16. Muscadine Fruit Quality and Food Safety	26
17. Resources	28
18. Literature.....	29

1. The Biology of the Wild Muscadine Grape (*Vitis rotundifolia* Michx.)

More than 50 wild grape (*Vitis*) species are known worldwide, with only a few of them being cultivated for ornamentals, rootstock, or fruit production. The most widely cultivated grape is the common grape vine, *Vitis vinifera*, which is native to parts of Europe, Northern Africa, and the Middle East. Merlot, Malbec, and Riesling are all *V. vinifera* cultivars (Table 1). Wild muscadines belong to the species *Vitis rotundifolia* Michx.; some scientists refer to wild muscadines as *Muscadinia rotundifolia* (Michx.) Small. Muscadines are believed to be the first cultivated native grape in the United States (Brown et al. 2016) and split from all other grape species relatively early over the course of evolution (Wan et al. 2013). They are native to the southeastern United States and differ from other grape species in many regards: unbranched tendrils, berries with thick skins and a unique fruity aroma, small cluster size, and berries that abscise from the cluster. Muscadine vines also have a higher number of chromosomes

($2n=40$)¹ compared to most other grape species ($2n=38$), making crosses between muscadines and other grapes difficult.

Little is known about the biology of wild muscadine grapevines. According to the United States Department of Agriculture’s Natural Resources Conservation Services (USDA-NRCS) Plant Database (USDA-NRCS 2018), muscadine grapevines are native to the southeastern United States. The east-west span of the native range reaches from Texas and Oklahoma to the eastern coastal plain, and the south-north distribution from Florida to Delaware. Wild muscadine grapevines are found in hot, humid-subtropical climates in the United States (Kottek et al. 2006). All muscadine cultivars are therefore considered to be adapted to high temperatures and humidity, and muscadines are generally tolerant or resistant to many of the native diseases and pests present in the Southeast. Muscadines grow in wild habitats throughout the southeastern United States, from the sandy soils of the coastal plain in North Carolina and South

Table 1. Origin of several grape cultivars used in the Southeast

Origin	Examples of Cultivars and Rootstocks	Background
<i>Vitis vinifera</i> (European)	Chardonnay, Merlot, Cabernet Franc, Petit Manseng, Petit Verdot, Cabernet Sauvignon	More than 2,000 years breeding history; susceptible to disease and pests
<i>Vitis labrusca</i> (American)	Niagara, Catawba, Sunbelt, Concord	Ca. 200 years of breeding history; less susceptible to diseases and pests
‘Hybrids’ (European x American), ‘French hybrids’ (Siebel x Siebel cross)	Traminette, Vidal Blanc, Noiret, Seyval Blanc, Chardonel, Chambourcin, Villard Blanc (French hybrid)	300–400 years known breeding history; moderate susceptibility to diseases and pests
<i>Vitis aestivalis</i> Hybrids (American / American x European)	Norton and Lomanto / Lenoir and Blanc du Bois	Important cultivars in NC, VA, and GA
<i>Vitis berlandieri</i> , <i>V. rupestris</i> , <i>V. cinerea</i> , <i>V. riparia</i> Rootstocks (American)	5BB, 125AA, 5C, 3309C, 110R etc.	Often used as rootstocks with hybrids and <i>vinifera</i> cultivars to increase soilborne pest tolerance
<i>Vitis rotundifolia</i> Muscadines (American)	Carlos, Noble, Doreen, Tara, Lane, Magnolia, Triumph, Supreme, Scuppernong, Paulk, Hall, Lane	Ca. 150 years of breeding history; tolerant to diseases, pests, humidity, and heat

¹ $2n$ refers to a double set of chromosomes; the number 40 refers to the total number of chromosomes. Normal somatic cells in humans also have two sets of chromosomes ($2n=46$). However, many crop plants can have more than two sets of chromosomes (for example, peanut, tobacco, watermelon, strawberry, and cotton).

Carolina to the forests of the mountains in North Carolina and Georgia. Wild muscadines can grow excessively, often as lianas on trees or overgrowing shrubs and bushes in forested areas (Figure 1).

Wild muscadine grapes are dioecious, which means individual plants may be male or female. As with most dioecious plants, complex interactions between wind pollination and insect pollination contribute to fruit set in wild muscadine grapes (Sampson et al. 2001; Muñoz-Rodríguez et al. 2011). Typically, wild muscadines produce dark-skinned berries within clusters containing 4 to 10 berries, which need 90 to 120 days to mature.

2. Modern Muscadine Cultivars

In the past few decades, the muscadine industry has evolved into a multimillion-dollar industry in the United States. To date, more than 100 muscadine cultivars have been released. Muscadine grapes are grown commercially all over the Southeast and are also grown to varying extents in California, Chile, and China. Breeders have taken increased interest in muscadines only in the last century even though the muscadine “mother-vine” — considered to be one of the oldest living grapevines in the world — was discovered about 400 years ago in North Carolina. As of 2019, the main muscadine breeding programs are at University of Georgia (public); University of Arkansas (public); North Carolina State University (public); Florida Agricultural and Mechanical University (public); Ison’s Nursery

& Vineyard Inc. (private), and Gardens Alive! Inc. (private). Self-fertility, large berry size, seedlessness, and enhanced eating quality (such as skin and pulp texture, and flavor) are the major goals of current muscadine breeding programs.

The most commonly used cultivars for wine and juice production are Carlos for white juice and Noble for red juice. Other cultivars with excellent juice production capacity are Doreen and Magnolia (Table 2). Carlos is by far the most widely planted muscadine grape cultivar; it is relatively cold hardy and a consistent producer of high crop yields. However, contrary to earlier recommendations, Carlos and Noble have demonstrated only limited value as fresh-market cultivars due to the small size and their short storage capacity. Carlos and Noble, however, are widely used and for juice and wine production. While all cultivars could be machine harvested, fresh-market production requires hand harvesting. Therefore, Carlos and Noble are typically the only cultivars that are mechanically picked for juice and wine production.

Fresh-market cultivars have different requirements than juice cultivars. Berry size is very important; cultivars with larger berries tend to demand the highest prices. If berries are packaged in plastic clamshell containers, medium to medium-large (3/4 to 1 inch diameter) berries are sufficient. However, if berries are to be marketed in open packs (for example, 20-pound boxes), where the consumer picks out individual berries, very large berries (1

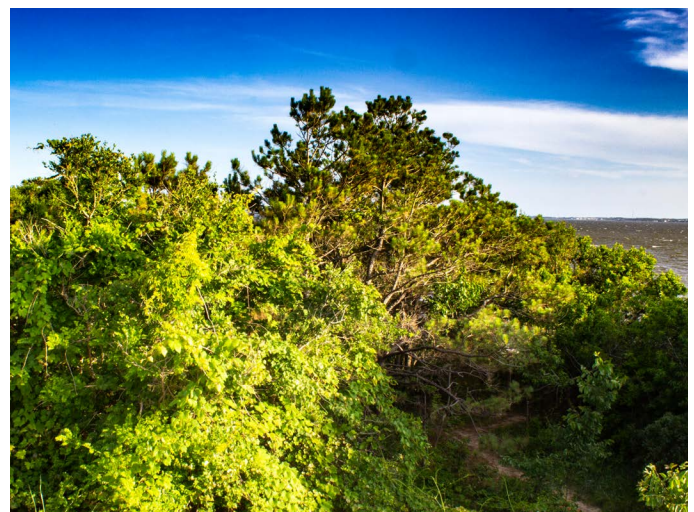

Figure 1. Left: A wild muscadine grape climbing a tree in South Carolina. Right: A wild muscadine grape overgrowing vegetation at the edge of a sand dune in North Carolina (photos by Mark Hoffmann).

to 1¼ inch diameter) are ideal. Berries should be firm with a dry picking scar so that leaked juice does not promote rotting and stickiness. Tender skins and high soluble solids (>14°Brix) are desired for optimum eating quality. Consumer preference for the black- or bronze-skinned cultivars varies by location, but generally growers will want to have some of each. Finally, cultivars should be chosen to ripen over the length of the harvest season so that product is marketable for as long as possible and to spread out harvest labor.

Examples of early season cultivars include Early Fry (bronze), Hall (bronze), Tara (bronze), Triumph (bronze), Lane (dark), and Black Fry (dark). Mid season cultivars include Darlene (bronze), Fry (bronze), Ison (dark), Supreme (dark), and Paulk (dark). Late season cultivars include Granny Val (bronze), Late Fry (bronze), and Nesbitt (dark) (Table 2).

Only a few seedless muscadine cultivars exist currently. Fry Seedless is an older seedless cultivar that produces a relatively small, pink berry. However, fruiting is too sparse and berry size too small for it to be a commercial cultivar. Gardens Alive! is producing seedless muscadine cultivars that were developed by crossing muscadines with seedless *V. vinifera* cultivars. The first of these, RazzMatazz, is a continuously fruiting vine producing very small, red seedless berries growing in clusters. In 2019, Gardens Alive! released a second cultivar, Oh My!, which produces a bronze mid-size to large berry. Both of these cultivars have received limited testing so far.

Early, cultivated vineyards consisted of female cultivars with interspersed male pollinizers, however, a few naturally occurring hermaphrodite (self-fertile) vines have been discovered. These vines are “perfect flowered,” functionally male and female, and are often referred to as self-fertile in the literature. The self-fertile muscadine flower consists of a normal pistil surrounded by five or more tall, erect stamens producing functional pollen

(Figure 2). In contrast, female flowers are imperfect hermaphrodites in which the stamens are recurved and shorter and the pollen is sterile. The male flowers have a whorl of erect stamens producing functional pollen and lacking a pistil. Through breeding, perfect flowers have been introduced into modern cultivars, and these now serve as pollinizers for the female cultivars that are still popularly grown.

We recommend that you plant a mix of female and self-fertile cultivars. In the past, large berry size was available only in female cultivars. However, new cultivars such as Paulk combine perfect flowers with large berry size, and many growers are phasing out female cultivars that require a pollinator and are often less productive.

If a female cultivar is used (for example, Fry or Supreme), a self-fertile cultivar must be used to ensure proper pollination. Female cultivars should be at a maximum distance of 50 feet from the pollinator (self-fertile). As a rule of thumb, a ratio of 3:1 (female:self-fertile) should be implemented in the field. As an example, you can alternate three rows of Supreme (female) with one row of Tara (self-fertile); this puts the female Supreme at a maximum and “safe” distance of 24 feet from the pollinator Tara if you use the conventional, commercial between-row spacing of 12 feet.

Where temperatures in winter frequently drop below 10°F, especially in the western part of the southeastern states and in mountainous areas of North Carolina and Georgia, the cultivars Noble, Nesbitt, Magnolia, Triumph, and Fry are considered to be relatively cold-tolerant. The Katuha Muscadine is currently under evaluation in a small, private cold-hardy selection program. The capacity to tolerate cold conditions, however, will ultimately also depend on vineyard management, pruning, and cropping levels (Eissenstat and Yanai 1997; Comas et al. 2000; Anderson et al. 2003; McCormack and Guo 2014) — even in cultivars with relatively greater cold tolerance.

Table 2. Characteristics of evaluated muscadine cultivars. Seasonal fruit development can differ depending on location.

Cultivar	Type	Fruit Color	Fruit Size	Cold-hardy	Season
Wine and Juice					
Carlos	Self-fertile	Bronze	Small-Medium	+	Mid
Doreen	Self-fertile	Bronze	Small-Medium	+	Late
Magnolia	Self-fertile	Bronze	Small-Medium	+	Mid
Noble	Self-fertile	Dark	Small-Medium	++	Mid
Fresh Market					
Black Beauty	Female	Dark	Large	++	Early-Mid
Black Fry	Female	Dark	Large	++	Mid
Darlene	Female	Bronze	Large	-	Early-Mid
Early Fry	Female	Bronze	Large		Early
Fry	Female	Bronze	Large	++	Mid
Granny Val	Self-fertile	Bronze	Large		Late
Hall	Self-fertile	Bronze	Medium-Large	-	Early
Ison	Self-fertile	Dark	Medium-Large		Mid
Lane	Self-fertile	Dark	Medium-Large	-	Early
Late Fry	Self-fertile	Bronze	Large	++	Late
Nesbitt	Self-fertile	Dark	Medium-Large	-	Mid-Late
Oh My!	Self-fertile	Bronze	Medium, seedl.	?	?
Paulk	Self-fertile	Dark	Large	-	Mid-Late
RazzMatazz	Self-fertile	Pink/Red	Small, seedl.	-	All year
Summit	Female	Bronze	Medium	+	Early-Mid
Supreme	Female	Dark	Large	-	Mid
Tara	Self-fertile	Bronze	Medium-Large	-	Early-Mid
Triumph	Self-fertile	Bronze	Medium	+	Early



Male

Perfect

Female

Figure 2. Close-ups of male, self-fertile (“perfect”), and female muscadine flower clusters (photos by Patrick Conner).

3. Costs and Estimated Returns

Table 3 presents the estimated costs for the establishment of a muscadine vineyard and Table 4 gives estimated costs for the maintenance. The practices described are general steps for vineyard establishment; costs will differ based on materials priced from the various suppliers and nurseries and with local labor costs. A hypothetical commercial vineyard is assumed to have 218 vines per acre with spacing of 12 feet between rows and 18 to 20

feet between vines (Poling et al. 2003). Estimated labor costs are \$12 per hour, not including taxes and benefits.

If the land must be cleared and prepared and an irrigation system installed, it will cost an estimated \$13,256 to \$19,106 per acre (including material and labor) to establish a muscadine vineyard (years 0-2) (Table 3). Establishment costs can be reduced to about \$8,400 per acre if the land clearing costs are lower (for example, removal of trees is not

Table 3. Projected estimated general costs per acre and timetable for the establishment of a muscadine vineyard. Year 0 indicates the year before planting (pre-plant). Years 1-2 are the first two years of establishment. Equipment costs are not included.

Year	Activity	Material	Material \$/acre	Labor ¹ \$/acre	Total \$/acre
0	Land clearing and leveling	Service ²	\$300–\$3,000		
	Soil cultivation	Service ²	\$50–\$300		
	Irrigation installation	Service ²	\$3,500–\$6,500		
	Grape vines (ordering)	218 vines/acre \$10 per vine	\$2,180		\$2,180
	Application of lime ³	-	-	-	-
	Weed control	Strip spray with Roundup	\$10	\$28	\$38
	Establishment of trellis system ⁴	218 4"x8" posts \$8 per piece 84 6"x8" posts \$12 per piece 42 4"x4" timbers \$12 per piece 3 rolls of 9" wire \$50 per roll Anchors, Fasteners etc.	\$1,744 \$1,008 \$504 \$150 \$200	\$600	\$4,406
1–2	Grape vine planting ⁵		-	\$1,080	\$1,080
	Pest control	Pesticide applications	\$20–\$50	\$72	\$92–\$122
	Training	Training on trellis (supplies include grow tubes, 6' bamboo stakes, orchard tape)	\$436	\$1,044	\$1,480
	Pruning		-	\$120	\$120
TOTAL COSTS					\$13,246–\$19,106

¹ Labor costs are an estimated \$12/hour and don't include taxes or benefits.

² Services include rental of equipment and labor. Irrigation includes the costs of a sand filter.

³ The amount of lime has to be determined based on a soil test and can vary widely.

⁴ Based on a 10-foot row spacing, 20 feet between vines, and 21 rows per acre (Poling et al. 2003)

⁵ Estimated 90 hours of labor per acre for digging holes and planting young vines.

necessary), general labor costs are lower, or irrigation water can be supplied by an existing water source. Costs will be higher when a deer fence is installed. Note that in the second year no harvest costs are incurred, but it will cost to thin the fruit.

The maintenance tasks of a mature muscadine vineyard can be broken down into pre-harvest cultural management, pest and weed management, harvest, and post-harvest management. A rough estimate of maintenance costs, including labor costs of \$12 per hour, range from \$1,950 per acre per year to \$3,750 per acre per year (Table 4). A small, surplus budget will help pay for replanting of dead grapevines due to winter damage, mechanical damage, or pest and disease issues.

Hand harvesting is necessary for fresh-market production, but a few wine and juice production operations also use hand harvesting. Hand harvesting is more expensive than mechanical harvesting (Table 4). Depending on the cultivar, grape ripening can occur over a span of three to six weeks. Therefore, in fresh-market or pick-your-own operations, several harvest events are necessary. On the other hand, mechanical harvesting generally

occurs only once for juice and wine cultivars regardless of ripeness consistency.

The cost to hire a mechanical harvest service will vary, but charges are incurred either by the hour or per ton of harvested fruit. Costs are variable and can run from \$200 to \$720 per acre. Mechanical harvesting is a cheaper alternative to hand harvesting and usually the choice for operations that focus on wine and juice production. However, mechanical harvesting can be used to harvest fresh-market cultivars that remain in the vineyard after the marketability for fresh eating, but that can still be used for processing. Catch-frame harvesting is a cheap alternative often performed by smaller operations. Harvest methods are discussed in Chapter 15.

Estimated returns for grapes vary depending on the purpose of use. If grapes are produced and sold for wine, returns range from \$200 per ton to \$600 per ton depending on the buyer, the market, and the quality of the grapes. Carlos and Noble vineyards can produce 4 to 11 tons of grapes per acre. At an average price of \$400 per ton and 8 tons per acre of production, the crop can be sold for \$3,200 per acre.

Table 4. Projected estimate of costs per acre for the maintenance of a muscadine vineyard per year. Equipment costs are not included.

Year	Activity	Material	Material \$/acre	Labor \$/acre	Total \$/acre
3 and following	Pre-harvest cultural management ¹ (fertilization, hedging, training, repairs etc.)	Fertilizer \$20/50lb	\$160	\$240	\$400
	Pest and weed management ² (spray applications, mowing, debris removal etc.)	Pesticides variable	\$200–\$500	\$480	\$680–\$980
	Harvest Hand harvest ³ Machine harvest ⁴	-	-	\$1,800 \$270–\$720	\$1,800 \$270–\$720
	Post-harvest cultural management ⁵ (debris removal, pruning)	-	-	\$600	\$600
TOTAL COSTS	Hand-harvest				\$3,480–\$3,780
	Machine harvest				\$1,950–\$2,400

¹20 hours of labor/acre are estimated for pre-harvest cultural management.

²40 hours of labor/acre are estimated for pest and weed management.

³60 hours of labor/acre are estimated for one pass of hand harvesting grapes (three harvest events are estimated).

⁴Rates to rent mechanical harvester can vary.

⁵50 hours of labor/acre are estimated for pruning and other post-harvest cultural management.

With machine harvesting, a return between \$800 and \$1,250 is possible. If the vineyard produces 5 tons per acre, however, the operation will barely break even. Crop yield is extremely important for financial sustainability, particularly when muscadines are produced for processing by an independent grower (and not as part of a winery operation).

More lucrative business models for muscadine wine production include tourism and a tasting room. A winery and a tasting room represent expensive up-front investments, often reaching several hundred thousand dollars. However, wine sales and agritourism also increase the return of revenues and offer potential means for greater enterprise sustainability.

On average, Carlos muscadines yield about 135 to 140 gallons of usable juice per ton of grapes (Poling et al. 2003). A case of wine contains 12 bottles, and each bottle holds 750 ml (or 0.198 gallons). The volume of wine in a case is a total of 2.378 gallons (0.198 x 12) Thus, 1 ton of muscadines is necessary to produce about 55 cases of wine. A bottle of muscadine wine sells for \$6 to \$12 per bottle. Eight tons per acre production yield about 440 cases of muscadine wine per acre, worth \$31,680 at a price of \$6 per bottle. Some wineries in North Carolina and Georgia also offer custom crush services to produce juice and wine.

The fresh-market muscadine sector is the fastest growing segment in the muscadine market. Muscadines are sold at farmers markets, roadside stands, pick-your-own operations, and supermarkets. Returns vary widely for fresh-market muscadines. Contracts with supermarket chains require a minimum acreage and the implementation of food safety measurements and quality standards. Fresh-market grapes must be presented to consumers in uniform size, color, and stage of ripeness to optimize marketability. At a roadside stand or a farmers market, fresh-picked muscadines sell for about \$12 per bucket. A bucket of muscadines holds about 5.5 pounds of grapes. One ton of muscadines equals about 363 buckets, worth \$4,356. Fresh-market cultivars tend to be lower yielding, often lower than Carlos, which is a high yielding cultivar. At 5 tons per acre of production,

1 acre of hand picked fresh-market muscadines yields about 1,815 buckets of muscadines, worth \$21,780 if sold for \$12 per bucket. Selling fresh-picked muscadines at farmers markets and roadside stands, however, can be a logistically challenging task and also implicates more labor, food-safety, and transportation costs, which are difficult to estimate.

4. Main Production Regions in North Carolina, South Carolina, and Georgia

Muscadine production areas in the Southeast are limited mostly by minimum temperatures over winter and late spring freezes and frosts. Most muscadine cultivars are sensitive to air temperatures that remain below 10°F for an extended time. Extreme cold temperatures can lead to damaged tissue and cracks, which can lead to canker and fungal wood infections and often to die-back or die-off in the following seasons. In spring, late frost and freeze events are common and can thoroughly injure a muscadine vine, resulting in trunk splitting and canker and fungal infections in severe cases. While muscadines are generally later breaking than their bunch grape counterparts, early bud-breaking cultivars often lose some of their primary buds.

The primary muscadine production areas are located in the southern piedmont of North Carolina, eastern coastal plain of North Carolina and South Carolina, and the piedmont and coastal plain of Georgia (Figure 3). Growing muscadines in the upper piedmont and foothills of North Carolina and the mountainous regions in Georgia and North

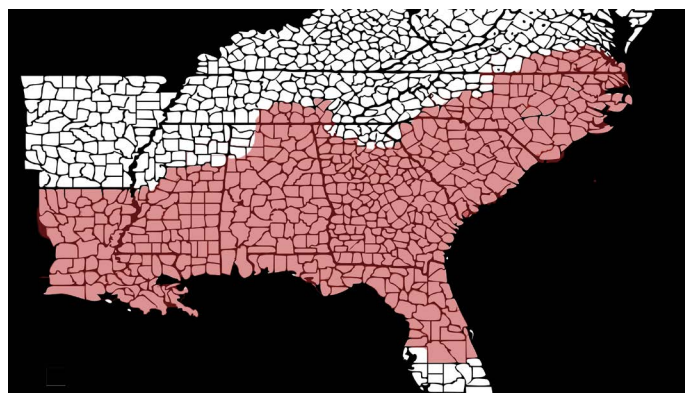

Figure 3. Muscadines can be grown in the U.S. from southeast Texas and north Florida up the Atlantic coast to southern Virginia and the southern parts of Tennessee.

Carolina can be challenging due to lower winter temperatures. Low acreages of muscadines are successfully planted at higher elevations in North Carolina and Georgia (Table 2). However, the selection of the site (see Chapter 7) and cultivar becomes highly critical in mountainous areas; we recommend that you contact your Cooperative Extension center or statewide small fruits and viticulture specialist (see Chapter 17) before investing time and money.

5. Climate Change and Muscadine Production

Weather patterns in the Southeast have dramatically changed over the past 30 to 40 years when compared to the first half of the 20th century. The number of days per year in which nighttime temperatures are above 75°F has doubled, while the number of heat days, in which temperatures exceed 95°F, have decreased. The average number of frost-free days per season, however, has increased in most regions in the Southeast by about 20 percent to 30 percent over the last 30 years (Terando et al. 2018). The number of days with heavy precipitation (more than 3 inches per rainfall event) has increased, especially in the main muscadine growing regions of the broader coastal areas in Georgia, South Carolina, and North Carolina. More rain and a higher frequency of severe rain events have contributed to more frequent flooding in the coastal plain of North Carolina, South Carolina, and Georgia (Terando et al. 2018).

Muscadines are a perennial crop and, if well managed, vines can be productive for several decades. Due to the unique capacity of muscadine vines to tolerate heat, humidity, and rainfall, it is probable that muscadines will adapt to future changing climate conditions better than other fruit crops. However, it is critical to think about several climate-related factors during the vineyard planning process. It may be most important to consider the vulnerability of the site to flooding and water-saturated ground. If possible, you should establish a new vineyard on land that is higher in elevation than surrounding land and away from areas that could potentially flood. A “hard pan” — a ground layer that keeps rainwater from passing through

the soil — exists in many locations of the coastal plain of the Carolinas and Georgia. After heavy rain events, water can fill up the shallow soil layers, which can lead to root hypoxia (lack of oxygen), rot, and substantial damage or die-off of a muscadine vine. We recommend that you test the ground for existing hard pans by using an auger at three to four selected spots at the site. Plant vines only if there is no hard ground layer detected 40 to 50 inches deep. Changing climate conditions also increase the risk of emerging invasive diseases and pests. We highly recommend establishing an emergency budget for replants, intensive pest management strategies, and accommodation for potential substantial harvest losses.

Finally, many areas in the Carolinas and Georgia are vulnerable to hurricane damage. Short- and long-term effects of severe weather events such as hurricanes on the local agriculture industry are hard to predict, which often leads to situations of insufficient preparation (Attaway 1999). Hurricanes bring high winds and destructive rainfall, and in recent years, several hurricanes that made landfall on the coast of the Carolinas and Georgia caused highly damaged muscadine vineyards (Figure 4), severe crop loss, and flooding. Given the perennial nature of muscadine vines and the time required to reach commercial production levels after planting new vines, it can take several years to recover from crop and vine loss due to physical vine damage and



Figure 4. Hurricane Florence in 2018 had a devastating impact on muscadine fields in North Carolina, especially in Duplin, Pender, Bladen, Sampson, Scotland, and Robeson counties. Shown are toppled rows of Noble shortly before harvest (photo by Mark Hoffmann).

death. Although it is hard to plan on a long-term scale to minimize damage in unpredictable scenarios such as hurricanes, several preventive measures can be taken before planning and planting a vineyard: (1) reduce row lengths to help reduce yield loss in the case of toppled-over grapes, (2) use frequent canopy management to help reduce the overall row surface, (3) find a slightly elevated field site several feet from the next creek to prevent water damage, (4) avoid field sites with low water drainage to help prevent water damage during and after heavy rain events, and (5) know the natural disaster resources for agriculture (see Chapter 17) to help you act fast and securely after potential hurricane damage.

6. Propagation

Disclaimer: Many cultivars are patented; it is illegal to propagate those cultivars without the consent of the patent holder. We recommend that you double check with the nursery, breeder, or your Cooperative Extension center before propagation. Moreover, self-propagation also increases the risk of introducing diseases (such as viruses and fungi) to the newly propagated grapevines. You can find more information about propagation at <https://content.ces.ncsu.edu/propagating-muscadine-grapes> (Fisk et al. 2008).

Layering

Muscadine grapevines can be propagated by air-layering or root-layering vines during the growth period (May through August). For root-layering, a portion of a new shoot can be covered with soil, leaving the growing end exposed. Roots will form where the branch is covered. The following winter or spring, you can cut off and transplant the rooted portion. To propagate a large number of plants by root-layering, you can lay the entire fruiting arm in a shallow trench and cover it with 4 to 5 inches of soil, leaving the tips of the shoots above ground. Each shoot will root and form a new plant.

Air-layering can be accomplished by using a healthy, young shoot on a vine and a plastic bottle whose bottom has been removed. The bottle is then stripped over the growing point of a shoot with its bottom first. The shoot needs to go out of the screw end opening of the plastic bottle (Figure 5). The

bottle needs to be filled with a propagation mix (for example, 1:1:1 peat:sand:pine bark ratio) and should be kept wet (with tap water or rainwater) (Fisk et al. 2008). When plants go dormant, you can remove the shoots and cut them into rooted sections. You can pot these or store the bare-root plants in cool, dry conditions and then plant them the following spring.

Softwood Cuttings

It is easier and quicker to propagate large quantities of plants with softwood cuttings taken post-bloom until mid summer (late June through July). Cut current-season shoots from the plant, discard the tender tip, and make cuttings from the rest of the shoot. Mist the cuttings or dunk them in water immediately to prevent wilting. Retain four nodes on each 4- to 6-inch cutting and remove the bottom two leaves. Place moist cuttings in a propagation bed containing a 50:50 (by volume) mixture of perlite to peat and use 3-by-4-inch spacing. You can also root plants in milled pine bark. You can use shade cloth or lath to block about 50 percent of the direct sunlight. Maintain humidity close to 100 percent by using mist nozzles that deliver about 2 gallons per hour at 30 to 50 pounds of pressure. No misting is



Figure 5. Air-layering propagation technique, using a 2-liter plastic bottle of soil mix inverted over vine shoots (Fisk et al. 2008).

needed at night or on very cloudy days. When the cuttings have rooted (after four to six weeks), remove the shade and gradually reduce the misting. Applying fertilizer is unnecessary unless you observe low rooting rates. If needed, apply a tablespoon of 10-10-10 complete fertilizer per gallon of water per 25 square feet of bed. Remove the rooted cuttings from the bed before winter. Shake the roots free of residual propagation mixture and remove all leaves from the cutting. Store cuttings at 38°F to 40°F in sealed plastic, a protected cold frame, or a refrigerated unit until late March or early April of the following year. Plants with well developed root systems can be planted in their permanent location; plants with poor root systems should be grown in a nursery row for an additional year before planting them in the vineyard.

7. Site Selection and Vineyard Establishment

Site Selection

Site and cultivar selection often go hand-in-hand because they both play a key role in the success and sustainability of a vineyard operation. Following are some important questions one should ask when selecting a site for a future muscadine vineyard:

1. **What is the purpose of the muscadine vineyard and does the selected site serve this purpose?** For example, if you plan a pick-your-own operation, it must be readily discoverable and accessed from a preferably well-travelled road. If the vineyard is designed to produce muscadine grapes for wine production, access by heavy machinery may be needed for building or mechanical harvesting purposes. A good vineyard or winery site may or may not be the same; the best winery site is near an area with high population density or well-traveled roads.
2. **Are the soil conditions appropriate for a muscadine vineyard?** Soil drainage is the most important aspect of soil suitability. Generally speaking, well-drained soil types commonly accustomed to tobacco production will also be suitable for muscadines. The area should not be prone to frequent flooding or standing water

after heavy rainfall. The site needs to be away from creeks and rivers, on slightly elevated land, and free of possible hard pan layers at 40 to 50 inches of depth. The testing procedure for hard pans is described in Chapter 5. It is important that soil pH is in a range that can be adjusted by liming. In some areas in the eastern coastal plain, soil pH can drop well below 5.0. A healthy pH range for muscadine vines is 5.5–6.5. A soil pH of 5.0 or lower is time-consuming and cost-intensive to adjust, so you should therefore avoid this land for a muscadine vineyard. To test your soil pH, take several combined soil samples from the first 0 to 6 inches and 6 to 12 inches (each depth should be a separate composite sample). You should take samples within blocks of land with even topography; a change in topography indicates a change in soil properties, so you should take a separate soil sample there. Send the samples to state testing facilities in North Carolina or Georgia (see Chapter 17).

3. **Does the field site have enough air drainage to avoid cold damage?** Most muscadine cultivars are cold sensitive and can suffer severe damage at temperatures below 10°F (Table 2) — this is especially common at sites in the piedmont, foothills, or mountains. Selecting a site with good air drainage is critical for the success of a vineyard (Figure 6). Sloped land usually offers good air and water drainage. Under these conditions, you should plant the vineyard on the upper half of a slope, not in the plateau and not in valleys or frost pockets. The elevation of a vineyard relative to its surroundings will influence its susceptibility to winter frost damage. Vineyard sites that are higher in elevation relative to their surroundings will have less frost and cold damage compared to those that are planted on sites lower than surrounding land. Barriers such as natural vegetation can hinder cold air from draining; remove such vegetation if it precludes cold air from flowing away from the vineyard. Cold damage can often lead to split cordons or trunks and predispose vines to woodborne fungal diseases or crown gall.

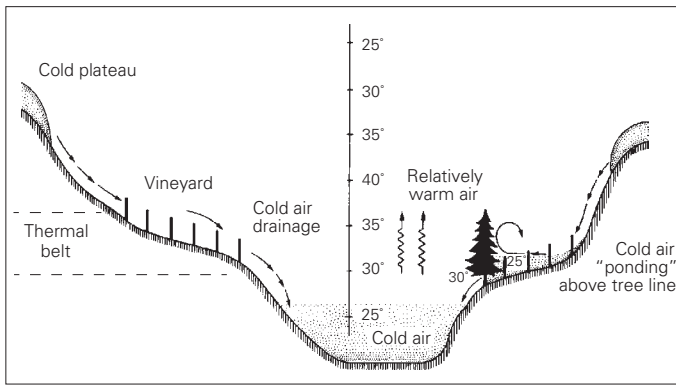

Figure 6. Effect of vineyard site topography on air temperature stratification during a radial cooling period (Poling and Spayd 2015).

Vineyard Establishment:

You should begin preparing land the year before planting. Perform soil testing early in the season and finish tillage, liming, and any other land clearing and grading tasks. Eliminate perennial weeds and pasture, and establish the trellis. Poling et al. (2003) recommends several key factors for effective vineyard establishment:

1. End-post costs can be reduced by maximizing row length (max 500 feet). Longer rows, however, bear a higher risk of yield loss, especially during high wind events (see Chapter 5). Long rows are often preferred if the vineyard is machine harvested, to increase equipment efficiency (for example, by limiting the number of turns and thus time required to spray, hedge, or harvest the vineyard).
2. Leave space for harvesters, crews, tractors, and mowers to move and turn around. Most cultivars require about 20-foot spacing between vines on a single-wire trellis. However, some fresh-market varieties might require less between-vine spacing. Research is in progress at the time of this publication to evaluate the effect of between-vine spacing on crop yield per unit of land and the evenness of ripening across the length of a single vine's cordon. Row widths of 10 to 12 feet are most popular. You should leave at least 30 to 40 feet at the ends of rows to allow equipment to turn around without hitting fences and natural vegetative barriers.
3. The slope and shape of the land are major determinants for row direction. If the land has more than a 2 percent slope, rows should be aligned at right angles to the slope (cross-slope planting) to minimize soil erosion. Running rows across a slope of 10 percent or greater (albeit not common for muscadine-growing regions), however, can be injurious to equipment and dangerous for operators; thus running rows up and down a slope of that magnitude is unsafe.
4. An additional soil sampling is required no later than the fall before planting. Often, lime is necessary to raise the soil pH. A pH of 6.0–6.5 is optimal for a muscadine grapevine. Dolomitic lime is preferred because it contains magnesium, which often becomes deficient in muscadine plants. Incorporate the lime and any recommended phosphate to a depth of 8 to 12 inches, five to six months before planting. While you can apply additional lime to the surface after planting, this practice is far less efficient at changing pH than applying and incorporating lime before planting.
5. Weed control is an important part of establishing a vineyard (see Chapter 10). Effective weed control before planting (pre-plant) is much easier to accomplish than after planting. Pre-plant applications of glyphosate (such as Roundup) should be implemented at sites with high weed pressure or on former pasture. Weeds compete with young muscadines for nutrients, water, and in some cases sunlight and are thus a major performance-limiting factor for young muscadine vines. Weed competition is particularly intense and undesirable in the first two years of vineyard establishment because weed and vine roots are both inhabiting shallow soil niches; the root systems of weeds and vines are thus at greater competition early in the life of the vineyard than later. Vine shelters (growth tubes) greatly increase the ability of young vines to outpace weed pressure because they protect vines from herbicides applied to surrounding weeds.
6. Soil erosion and soil structure in row middles can be controlled by planting a cover crop such as fescue or ryegrass. Note: Establish cover crops in row middles, *not* underneath the trellis near the vines, due to the same exerted competition by weeds.
7. In some areas, bedding up the rows before planting might be advisable. You can install

trellis systems either before or after planting, depending on the planting method. Machine planting can be performed only before installation of the trellis.

Irrigation

Since young vine roots occupy shallow soil depths, they are subject to drying out under drought conditions. Irrigation is necessary for the development of a healthy muscadine root system during the first two to three years of vineyard establishment. Irrigation becomes generally less necessary after the first three years of vine growth. During the past two decades, however, drought periods have been common during the growing season (see Chapter 5). Irrigation systems therefore may be more important in the future. Either overhead or drip irrigation systems are acceptable. However, overhead irrigation systems might facilitate the spread of certain fungal diseases and also can reduce pollination and fruit set when used during bloom. Moreover, overhead irrigation does not efficiently use water, cannot be used for fertilization purposes (fertigation), and is more expensive than drip irrigation. Many muscadine vineyards have installed drip irrigation systems that can be fully automated and make the most efficient use of water. Hand watering is also an option but is not advisable for a larger acreage.

You should avoid overwatering of the vines at all times. During periods in which little or no rainfall occurs, 1 inch of water per week is usually adequate.

Drip irrigation requires a sand filter for water from ponds and lakes. Water from most wells can be filtered inexpensively unless it has high iron content. We highly recommend that you ask an authorized irrigation supplier in your area to evaluate your vineyard site and to properly design an appropriate system.

Water quality must be measured. If using overhead irrigation from a pond or surface source, frequent testing for bacterial infectious diseases will be required for food safety. The filter and equipment will have to be cleaned frequently due to intrusive sediment from the water source. Check with your

Cooperative Extension center and suppliers to identify regulations. If you are drip irrigating, well-water testing will identify the characteristics of the water and its effect on the system. Test results may lead you to install equipment to mitigate potential problems due to water quality (for example, fine filtration, acidifiers, or emitter type).

8. Trellis and Planting

Trellis Systems:

The most common trellis system for commercial muscadine production is the *single, vertical high-wire system*. An alternative, the *Geneva Double Curtain (GDC)*, is a divided canopy training system, which can be a viable though costly commercial option. Muscadine growers rarely use divided canopy systems due to the increased upfront costs and increased labor and time to maintain system integrity. Table 3 gives establishment costs for a single, vertical high-wire system. The establishment of a GDC will increase the establishment costs.

To establish a trellis system of any type, several tools and materials are needed. Excavators or excavation companies will help to level land. Tractor powered augers are useful for drilling holes for posts, and tractor powered post drivers are needed to drive posts into the ground. Use tape measures to keep a consistent distance between rows and between posts. Use wire strainers, brace pins, leg staples, crimping sleeves, a wire wheel, hammer, and rubber mallet to install the trellis wire. Use flags and a long wire to establish straight rows and mark the spots for the posts. Please note that some fencing companies have the capacity to establish vineyard trellis systems and are commonly hired for trellis installation in commercial vineyards.

Steel or pressure-treated wood posts can be used to construct the single, vertical high-wire system. Both wood and steel have advantages and disadvantages. Wood posts are usually cheaper than steel, while steel usually is more durable. Wood posts are generally more difficult to install than steel posts, given their relatively greater diameter in width. This greater width diameter, however, may make wood posts less apt to be pushed over by strong winds than steel posts. Pressure-treated wood

posts should be also chemically treated to maintain their integrity over time; organic growers must use untreated wood posts. The bracing end-posts and the interior supporting posts should be between 8 and 8½ feet long. Wood posts no smaller than 5 to 6 inches in diameter should be used as end-posts, with posts no less than 3 inches in diameter for interior positions. The 8-gauge steel posts that are usually marketed for commercial wine grape vineyards are not strong enough to hold the weight of a fully developed muscadine vineyard before harvest. We recommend 12- to 13-gauge steel posts in muscadine vineyards; 10- to 11-gauge steel posts may suffice if post spacing is reduced. Use wood end-posts even if the interior posts are all steel.

Place 2½ to 3 feet of the end-post below ground, establishing the wire and vine height at 5 to 5½ feet. Posts should be 20 feet apart in the row but could be closer if the site is very sandy or subject to high crosswinds, or if closer between-vine spacing is used within the row. Brace the end-posts according to Figure 7, using 12.5-gauge high-tensile wire. Install a wire tensioner at the end of each row to help establish and maintain wire tension. There are several methods for bracing end-posts. We encourage new growers to talk with veteran growers and visit several established vineyards before making a final decision on bracing procedure. Most bracing techniques set the end-posts deeper than interior posts with braces at a 15- to 30-degree angle to the ground.

To determine proper row orientation, you must consider high-priority factors such as slope, air drainage, water drainage, and the ability to move equipment. The single, vertical high-wire trellis system allows machine harvesting with a conventional mechanized harvester and is commonly used in vineyards established for wine or juice production.

The establishment of a GDC is recommended only if no mechanized harvesting is planned. Line posts should be 8 feet long and placed 2½ feet in the ground and 20 feet apart (Figure 8). The end post should be 8½ feet long, at least 5 inches in diameter, and placed 4 feet in the ground at a

slightly outward angle. Use a 6½-foot post as an inside brace post. Position the inside brace post 6 feet from the outside brace post, and brace the top of the two posts with a four-by-four or equivalent piece of lumber. Run a double 9-gauge wire from the top of the inside brace post to the bottom of the outside brace post, and twist it to tighten the entire brace system. Metal cross arms (supports) commercially fabricated from galvanized steel are generally used with new plantings. These arms are very durable and easy to install on the posts. Wire to support the plantings can be quickly attached to the cross arm with a hairpin-type clip. Wooden cross arms also can be used. These cross arms are made from two two-by-fours or the equivalent. The supports are 29 inches long and predrilled 2 inches from the end to accommodate three 8-by-8-inch galvanized bolts. An additional hole is predrilled from the other end of the support parallel to the ground to

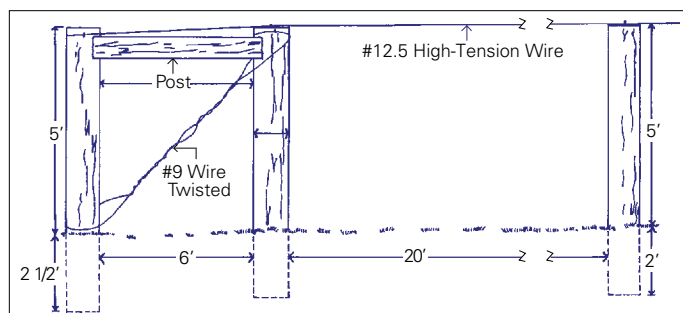

Figure 7. The most common trellis system for muscadines is the single, vertical high-wire trellis (modified, after Poling et al. 2003).

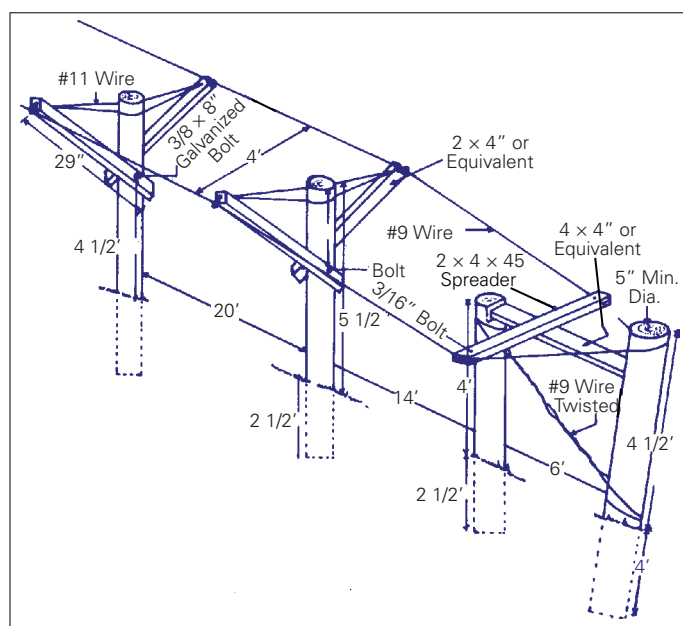

Figure 8. The modified Geneva Double Curtain (GDC) trellis (Poling et al. 2003).

allow the 11-gauge brace wire to pass through. After passing the loop end of the doubled wire through the support, place a 3/4-inch washer over the loop and attach a chain repair link to the loop (Figure 9). The brace wires are now fastened around the top of the post so the supports form a Y shape. Both should have angles approximately 35 degrees with the ground and measure 4 feet from tip to tip. Space between rows (post to post) should be no less than 10 feet. Nine-gauge wire can be used for the main wires. Fasten both main wires to the top of the outside brace post, thread them through a 45-inch spreader, and then run them down either side of the trellis through chain repair links. Brace the opposite end of the trellis in the same way with the two wires tightened around the top of the outside brace post.

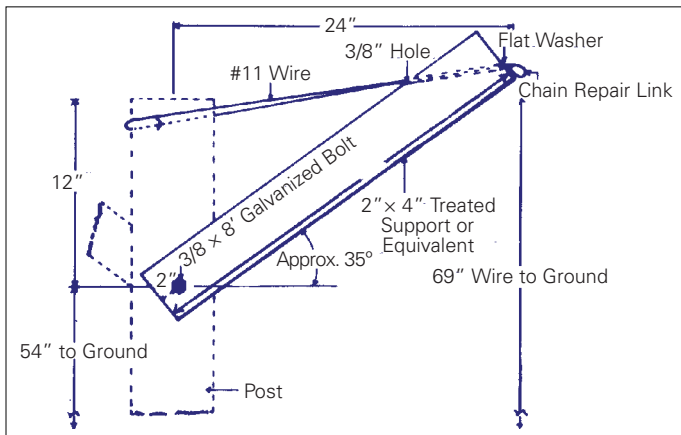

Figure 9. The support system for a Geneva Double Curtain (GDC) (Poling et al. 2003).

Planting

Upon vine delivery, moisten dormant roots, seal plants in plastic bags, and store in a refrigerated area (38°F to 40°F). Many nurseries will ship dormant vines in packaging that contains moistened paper, so these vines should remain moist in refrigeration. If refrigeration is not available, you could buffer the temperature by laying vines along the north side of a building and protecting them with loose straw or similar material about 1 foot thick. To avoid freeze damage to tender growth, postpone planting until there is little chance of a hard freeze. Keep in mind, however, the longer planting is delayed, the more likely plants will suffer from high temperatures and drought. Ideal planting windows vary greatly based on the typical weather patterns of a given locale. In North Carolina, the ideal planting window for dormant plants is in late April to mid May, while in

Georgia and South Carolina mid April to early May are ideal planting dates. In any case, you should minimize possible cold injuries of the young plants due to spring frost. Fall planting is possible but increased winter injury may occur. We do not advise planting in summer.

Planting holes and alignment. You can dig the planting holes by hand or tractor-powered auger; holes should be several times larger than the root ball of the grapevine. An auger will suffice for drilling planting holes. However, when augers are used in wet, heavy clay soils, a “pot” may form in the ground, and this sealed hole will not drain well; it will also not allow for good root growth outside of the planting hole. Therefore, it is best to not plant in soils with high clay content when they are wet. During planting, you should temporarily submerge vine roots in a pail of water or wrap them in wet burlap while they are distributed to the field planting sites. Make sure that roots are fanned out (not curled in a planting hole) and have enough space to grow without becoming root-bound. After planting, water the vines. Pack the soil firmly after the hole is filled, and irrigate or hand water the soil surface immediately. Often the soil in a planting hole collapses after watering and you need to fill the hole with extra soil. Do not apply fertilizer directly in the planting hole. Plant vines as deeply as they were planted in the nursery, and 12 to 18 inches from the posts. Setting vines against the posts may result in plant injury from the toxic wood preservatives and also will make it much harder to replace, train, and prune vines. You can also plant vines in the middle of two posts, particularly if they are spaced less than 18 feet apart. After planting, the young vines are vulnerable to freeze and drought damage. In a single, high-wire system, vines should be set directly under the trellis. In a GDC, vines should be planted in the middle between the two wires. Vines out of line are more likely to be injured by cultivation, mowing, and harvesting.

Vine shelters (grow tubes) are reusable plastic cylinders that are 24 to 36 inches tall and 3 to 4 inches in diameter. Vine shelters help to protect the young vines from deer damage and herbicide treatments. Temperatures inside a vine shelter are usually higher than outside temperatures;

consequently, vine shelters can lead to early bud-break and an increased risk of frost damage in spring. Further, in the fall, the shelters can reduce the vine's ability to harden off and acclimate to colder temperatures. We recommend that you take the shelters off in August and put them back on, if needed, before bud-break the following spring. Vine shelters allow herbicide to be applied in a newly planted vineyard and also protect the young vines from animal herbivory. Controlling weeds is especially important in a new planting due to the competition for soil nutrients and water between weeds and shallow grapevine roots. Therefore, vine shelters could practically be considered "animal and herbicide protection tubes."

9. Training and Pruning

Training

In the establishment phase of a vineyard (during the first two or three years), muscadine grapevines need regular training (Figure 10). Training establishes the optimal shape and position of the vine to optimize vineyard management and productivity in its cultivation. Proper training is accomplished by selecting a single shoot and training it up a bamboo stake or string. You can use various materials for attaching vines to the stake. The current standard material for tying green shoots to stakes is a plastic tape sold by most vineyard supply companies. Young vines need to be trained up the stake or string to the wire. The trunk needs to be pruned back to approximately 4 to 5 inches below the wire in the first winter. In the following spring (the beginning of the second growing season), choose two of the lateral branches and begin training them bilaterally along the wire as future arms (cordons) so that the trunk will branch in a V shape about 4 to 6 inches

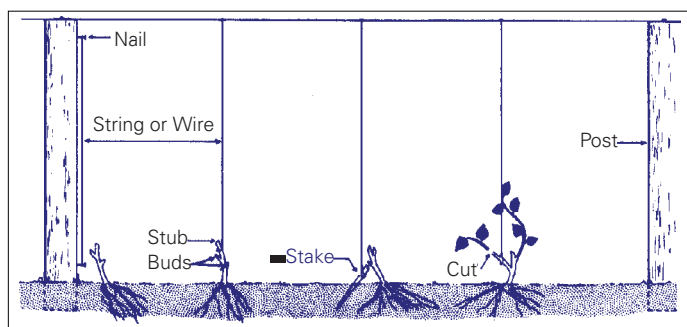

Figure 10. How to train, stake, and prune young muscadine vines (Poling et al. 2003).

below the wire. Continually remove lateral suckers along the trunk to direct all the plant's growth into the growing tips of the cordons.

Cordons can be twisted around the wire in long, wide twists and attached to the wire with plastic tape or rubber chains that can be obtained from a vineyard supplier. Twists should be at least 5 inches wide and should avoid the post. Cordons can also be attached to the wire with rubber chains and not twisted around the wire. Leave enough space to prevent the cordon from growing into and around the trellis wire. Until the cordons reach full length, cut back lateral shoots by about 4 to 6 inches during the growing season. Remove all fruit at the earliest stage until the cordons are fully developed so that the vine can invest energy into building permanent vine structures.

Pruning

Pruning is key to maintaining the longevity and productivity of a vineyard and needs to occur during dormancy, between December and March. Without proper pruning, a muscadine vineyard can rapidly become a financial burden. Unpruned muscadines can get out of hand very quickly, and it is extremely time-intensive to prune an abandoned muscadine vine (Figure 11).

If a vine remains neglected or poorly pruned, the unpruned wood often harbors diseases that can affect the entire vine and lead to parts of the cordons being less vigorous or even having no



Figure 11. A muscadine vine overgrows an abandoned car (photo by Mark Hoffmann).

growth at all (“dead arms”). As a general pruning rule, only an appropriate amount of last years’ wood should be left on the vine after manual or mechanical pruning has been completed. One-year-old wood is the only tissue source that will produce fruitful shoots in the coming season. Wood that is older than one year and is not part of the structural part of a plant (cordon, trunk, or spur) should be removed in the winter.

The choice of manual or mechanical pruning depends on the labor-to-acreage ratio. High ratios may allow each vine to receive annual hand-pruning (manual) while low ratios allow less frequent manual pruning. Manual pruning allows precise selection of one-year-old wood, especially that which is fruitful, and also optimizes the removal of any diseased or older wood. Mechanical pruning is not selective and usually leaves a greater amount of unfruitful, one-year-old wood and also retains undesirable amounts of diseased wood. Many operations don’t have the labor to manually prune all vineyard acreage every year and need to use mechanical pruning. In such cases, we highly recommended manually pruning a different section of the vineyard on a three- to five-year rotation and to mechanically prune the remaining acreage of the vineyard.

The choice of high-quality pruning tools facilitates fast and clean pruning and also helps to avoid muscle fatigue. Good quality by-pass pruning shears and loppers are recommended for muscadine pruning. Contact your North Carolina Cooperative Extension agent or viticulture specialist for recommendations (see Chapter 17). Hydraulic-end electric pruning tools (such as hedgers) can be used for pre-pruning to decrease the time to complete manual pruning; they might be a good consideration for some larger-acreage operations. Commercial battery-powered electric pruning shears (Figure 12) have rechargeable lithium batteries and are suitable for all-day use for manual pruning of muscadines.

In a “balanced pruning” approach, the vigor and fruiting capacity of an individual vine is assessed before pruning. Less one-year-old wood should be kept on a weaker growing vine, and more buds can be kept on a stronger growing vine. Balanced pruning aims to balance the vine’s capacity to carry



Figure 12. Battery powered pruning shears (photo by Bill Cline).

out vegetative and reproductive (flower and fruit) growth. Aiming for a balanced vine, whether it has weak or extensive growth, is important for the longevity of the vineyard and the consistency of production. Vineyard site, management practices, and cultivar choice will dictate vine vigor. Balanced pruning has three main goals: (1) to ripen fruit to full maturity, (2) to ripen wood to maximum maturity for better cold hardiness, and (3) to ensure that consistent and economical crop yields are sustained over time.

Balanced pruning is a research driven approach and is based on measuring the weight of canes to estimate a healthy reproductive and vegetative capacity of a vine. Buds are counted and a formula is used to estimate how many buds to leave on the vine. For example, a 40 + 10 formula is used for the juice bunch-grape cultivar Niagara. That means 40 buds will be left on the vine for the first pound of pruning weight and another 10 buds will be retained for each additional pound of pruning weight.

Muscadine vines are much more vigorous than most other grape cultivars. Figure 13 shows a healthy

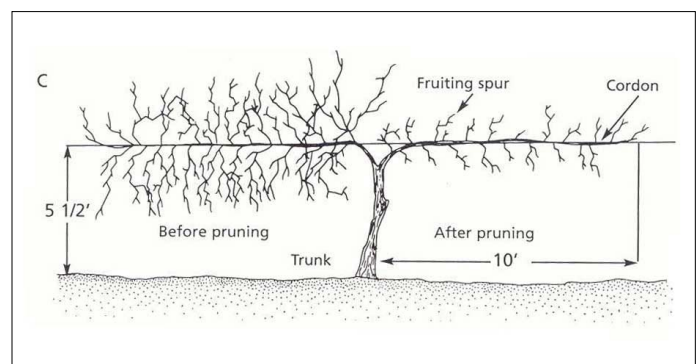

Figure 13. A healthy muscadine vine structure before (left) and after (right) pruning (Poling et al. 2016).



Figure 14. A healthy fruiting spur. Typically, a healthy spur would be selected every 5 to 6 inches along the cordon. Spurs can be pruned to 4 to 7 inches of length (photo by Barclay Poling).

muscadine vine structure. The trunk supports two permanent arms (cordons), which support the new fruiting wood every year. New shoots will develop from small fruit buds that are found on one-year-old fruiting spurs (Figure 14).

New shoots will support the fruit clusters, which usually develop near the base of the current season's shoots. One-year-old wood can be distinguished from other wood by the presence of buds. One-year-old wood is light tan to brown in color, compared to the gray color of older wood. One-year-old wood also has a cinnamon-colored, speckled appearance that makes it distinguishable from older wood. Buds on one-year-old wood are the ones you should count to achieve a balanced pruning. Do not include basal buds, those that originate at the junction of one-year-old and two-year-old wood, in the counting (Figure 13).

Poling et al. (2016) showed that between 15 and 25 buds per foot of cordon should be retained on a Carlos vine. The corresponding formula on a Carlos vine is $120 + 20$ (Poling et al. 2016). For a healthy mature Carlos individual on a 20 ft spacing, 400 one year old buds per vine can be retained. For less vigorous cultivars, formulas such as $100 + 20$ or $100 + 15$ seem more appropriate. To estimate the amount of buds to leave on a vine, weigh the one-year-old wood that was cut after rough pruning as a reference. With older vines and older cordons, it is important to distinguish one-year-old fruiting

wood from older wood. Older cordons often develop wood structures called bearers. Bearers consist of wood of variable ages that has grown over the lifetime of a cordon. One-year-old wood often is formed at the end of bearers. Over time, the bearer-spur complexes complicate pruning and also make canopy management more challenging. As a general rule, cordons should be replaced every six to seven years, and bearers (complexes of one-year-old spurs) should be renewed at a similar frequency. Renewing and replacing these perennial vine structures will reduce the impact of disease on the vine and also simplify pruning and hedging.

Five steps to a balanced pruning approach, according to Poling et al. (2016):

1. Complete an initial rough mechanical pruning before manual pruning, especially with mature vines. Sharp long-handled loppers and sharp one-handed pruners are essential for muscadine pruning. It can take 15 to 30 minutes to prune a mature vine, if mechanically pruned already. Muscadine wood is very hard and dense, and loppers and pruners should be always in pristine shape to avoid hand and muscle fatigue. Pressure- or battery-operated automatic pruners and loppers are an expensive but valuable alternative if a larger acreage needs pruning.
2. Conduct manual pruning any time from January through March. Remove 80 to 90 percent of the one-year-old wood. Even after a rough pruning, often 75 to 100 buds per foot of cordon are still left. The aim is to retain 20 to 30 buds per foot of cordon. Determine the number of buds by taking pruning weights of some vigorous and some less vigorous vines.
3. Try to retain healthy fruiting spurs at intervals between 3 to 7 inches along the cordon depending on the amount of buds to be retained per foot of cordon. Spurs should have five buds max. For example, if you want to retain 20 buds per foot of cordon, you could select five spurs per foot of cordon with each having four buds. Or you could select six spurs per foot of cordon, with four of them having three buds and two having four buds.

4. Select quality wood as spurs. A high-quality spur should be brighter in color than unfruitful wood and should have about the diameter of a pencil. Prune out any thinner wood.
5. Retrain and replace older cordons with wide gaps.

10. Canopy Management

Canopy management in muscadine vineyards is an important tool to optimize vine health, fruit quality, and disease control. Muscadine canopy management takes place between fruit set and harvest, and can include several steps: hedging, skirting, and fruit thinning. The extent of canopy management depends on the cultivar, vigor, and market purpose of the crop. Canopy management is perhaps of greater importance for fresh-market cultivars compared to juice cultivars, as aesthetics and easy access to the fruit are more important in fresh-market muscadines than in processed muscadines.

Hedging: Hedging is the most important canopy management in muscadines and is usually done two to three times a year — starting in early summer (June), a second time before harvest (July and August), and in fresh-market operations often again in September. A muscadine vineyard needs to be hedged on both sides of a row, under the vines, and on top of the row. A mechanical hedger (mounted to a tractor) is recommended for larger acreages. In a mature, healthy vineyard, leave 3 to 4 feet of space between the ground and the canopy. Frequent hedging helps to keep the rows accessible for spray applications and weed management. Hedging also allows better spray coverage and light penetration. Hedging underneath a vine is called skirting and should be performed frequently in a vineyard. Vigorous cultivars such as Carlos require more skirting than less vigorous cultivars.

You must also prevent shoots from crawling along the ground and keep neighboring vines from growing into each other. Shoots can grow into the canopy of the neighboring vine. If unchecked, intergrown vines can lead to time-intensive pruning and harvest operations and can increase the risk of building up disease pockets. Remove shoots at the outer edges

of a cordon to allow a 6- to 12-inch space between two neighboring vines.

Fruit thinning: Some growers remove fruit clusters to sustain perennial vine productivity. Fruit thinning is especially important in cultivars that tend to produce large amounts of fruit clusters with only moderate canopy vigor. The fresh-market cultivar Supreme and several other self-fertile, fresh-market cultivars (such as Hall, Lane, and Paulk, all recently released by University of Georgia's breeding program) should be judiciously thinned when their crop load is too high to maintain perennial vine health. Thin out fruit clusters within a month after fruit set; later thinning will be less efficient due to canopy growth and will result in fewer beneficial effects on fruit size and quality.

11. Liming, Nutrient, and Fertilizer Management

Nutrient Management:

Soil and plant nutrient testing should be routine tasks of a vineyard manager. Take the first soil samples early in the establishment phase (pre-plant) and make adjustments such as liming and pre-plant fertilizer, if applicable.

Take a combined soil sample from a defined block with a consistent soil type (maximum 10 acres) before applying fertilizer. Soil samples should be taken within 0 to 6 inches depth and within 6 to 12 inches depth. Keep shallow and deep samples separate and remove the grassy, organic matter from the top of the shallow soil core before mixing samples. Combine a minimum of 10 samples per block. Soil samples can be analyzed for nutrients and pH at the North Carolina Department of Agriculture & Consumer Services or the University of Georgia Plant Tissue and Soil Analysis Lab (see Chapter 17).

You should take whole leaf samples from vines two years and older of the same cultivar at bloom; collect the leaf (petiole and leaf blade) from opposite a fruit cluster. Combine 60 to 80 leaves from a defined block of vines. You can take a second set of leaf samples about 90 to 120 days after the first bloom. Select one of the last few, fully developed leaves

from the top of a primary shoot (one that originates from one-year-old wood) — not from a lateral shoot, which grows laterally off a primary shoot. Leaf samples can also be analyzed for nutrients at NCDA&CS and UGA. Table 5 shows target nutrient levels for mature muscadine vines. Current research is underway in Georgia and North Carolina to determine if these nutrient sufficiency ranges are reasonable across a wide range of climatic conditions and soil types.

Table 5. Appropriate levels of nutrients based on leaf analysis during bloom (Poling et al. 2003)

Element (Unit)	Optimal Range
Nitrogen (%)	1.65–2.15
Phosphorus (%)	0.12–0.18
Potassium (%)	0.8–1.2
Calcium (%)	0.7–1.1
Magnesium (%)	0.15–0.25
Boron (ppm)	15–25
Copper (ppm)	5–10
Iron (ppm)	60–120
Manganese (ppm)	60–150
Molybdenum (ppm)	0.14–0.35
Zinc (ppm)	18–35

Liming

In the Southeast, soils are often acidic, which means they have a pH level that is below the neutral pH of 7.0. Acidic soils limit the amount of nutrients that are readily available for plant uptake. Soils below a pH of 6.0 can lead to deficiency in nutrient uptake in muscadine vines. It is important to test the soil before planting and apply lime at the appropriate rate, aiming for a pH of 6.5 to 7.0. Lime application is far more efficient, effective, and cost-effective when it can be incorporated into the soil before planting. In mature vineyards, you should apply lime frequently (every other year) at low rates in the row middles, depending on the soil test results.

Fertilizer Management

Fertilizer management of muscadines is based mostly on anecdotal knowledge. Generally, field sites with a higher SOM (>3 percent) will not require

the same amount of fertilizer as sandy and sandy-loam soils, which tend to have relatively low SOM. Some growers only spot-treat their vines with a 10-10-10 if petiole sample tests indicate deficiencies. In the sandy soils of the coastal plain with low organic matter (<2 percent), yearly or bi-yearly fertilizer applications are common practice. As a general rule, you should carefully determine and execute fertilizer treatments. To reduce enterprise budget costs and to limit off-target environmental effects, it is important not to overapply fertilizer. Overall growth and vigor of a vineyard and manifestation of visual nutrient deficiency symptoms will also aid in eliciting sound nutrient and fertilization decisions.

Apply a small amount of a complete fertilizer (such as 10-10-10 or 12-12-12) in an 18-inch circle around each vine, beginning two weeks after planting and continuing on a monthly basis through August (Poling et al. 2003). During the second year, the amounts could be doubled. Many growers successfully use tobacco fertilizer (6-6-18) for the establishment and continuous fertilization of a muscadine vineyard.

In mature muscadine vineyards (after the second year), accurate determination of fertilizer needs is essential; it should be based on the most recent soil and petiole samples, and the overall growth and vigor of the vines. Fertilizer can be broadcast or applied under the row middles within a 2-foot distance to both sides of the vine. You can apply fertilizer as often as three times in spring; you should not apply it after July because that can lead to poor acclimation to colder temperatures and ultimately winter injury.

Within the last decade, fertilization through the drip system (fertigation) has become popular with growers of blueberries, pecans, blackberries, grapes, and other perennial fruiting crops. Fertigation delivers fertilizer directly to the soil during irrigation. Application rates depend upon demand. For example, a newly established planting at 20 feet by 12 feet will contain 182 plants per acre. At 0.25 pounds of 10-10-10 per plant, the fertigation rate for a 10-5-5 fertilizer would be $\frac{3}{4}$ gallon delivered to an acre weekly until the end of July in the piedmont and mountains and until the end of August in the

coastal plain. For 7-0-7 liquid fertilizer formula, an application of 1.1 gallons per week per acre would be applied.

Fertilizer Deficiency Symptoms

Nitrogen (in soils with lower SOM), boron, and magnesium are the elements that are most likely to limit muscadine grape production.

Nitrogen management of a mature vineyard (three years and older) is best determined by observations. You can determine nitrogen deficiencies by observing yellowing of foliage (especially on older leaves), shorter shoot growth, smaller leaves, and a reduction in fruit set (as observed by fewer berries per cluster). An oversupply of nitrogen can easily lead to excessive vigorous growth, later fruit ripening, exacerbated rotting of fruit, and potentially poor acclimation to colder temperatures in late fall and winter. If those symptoms are observed in a vineyard, overfertilization might be the underlying cause. Overfertilization will increase maintenance costs and the risk of frost damage, lead to damaged trunks and cordons, and lead to fungal infections with woodborne pathogens. Nutrition analysis of petiole samples in a mature vineyard can help to determine nitrogen status, but we recommend these objective analyses be enhanced by visual observations of symptoms and growth patterns.

Boron deficiency may result in poor fruit set. Leaf symptoms develop on newer, terminal leaves first. Interveinal chlorosis, die-back of terminal shoots, and a prolific growth of lateral shoots are all common symptoms of boron deficiency. Boron deficiency is more common in sandy soils. Visible symptoms generally do not appear until the vine is critically deficient. For mature vineyards, 5 pounds of Borax (10 percent) can be applied every other year, or 1 pound per 100 gallons of water of Solubor (20 percent) can be applied every year before bloom. Judicious boron application should be based on plant tissue analyses because too much boron will injure plants.

Magnesium deficiency has similar symptoms as boron deficiency but usually basal leaves are symptomatic first. Severe magnesium deficiency shows only later in the season. Epsom salt can

provide a quick fix for magnesium deficiency. However, long-term solutions often include the elevation of soil pH to 6.0–6.5 by additional liming and a change in fertilizer regime.

12. Weed Management and Herbicide Injury

Weed Management

The *Southeast Regional Muscadine Grape Integrated Management Guide* (smallfruits.org/files/2019/06/Muscadine-IMG.pdf) contains detailed information on weed management and labelled products. The primary goal of a weed management program is to minimize the competition between muscadines and weed species for nutrients, water, and light. Weed management is essential during the establishment phase of a vineyard and to the maintenance of a healthy vineyard. Weed control through June and July is important, especially in newly established vineyards. You must protect newly planted vines from direct contact with herbicides by using vine shelters (grow tubes). Place vine shelters around vines soon after planting and do not remove them until late summer or fall, after the last herbicide application of the season. Using vine shelters in the second season is also highly recommended, particularly if trunks were not well established after the first growing season.

Herbicide rotation is necessary to avoid development of herbicide resistant weeds or the selection of weed species that are not controlled by a particular herbicide. Herbicides with different modes of actions (MOA) should be rotated or tank mixed.

Weed management is critical during the first three years of a new vineyard. Weed control should be part of site preparation; it is best to control perennial weeds prior to vineyard establishment. Weeds like bermudagrass and Johnsongrass are highly competitive with vines for water and nutrients. Perennial weeds like blackberry, dogfennel, horsenettle, and thistles can be controlled with selective broadleaf post-emergence herbicides, but you need to treat in the summer or fall prior to vineyard establishment. Proper tilling techniques and

systemic herbicides (such as glyphosate products) can minimize or eradicate many problem weeds before planting. Pre-emergence herbicides can be used to prevent weed emergence. To maintain control throughout the growing season, at least two to three herbicide applications are required. The timing of these herbicide applications is very important to developing a successful weed control program. Pre-emergence herbicides are effective only after it has rained or overhead irrigation is used — watering in is necessary for their activation. Most pre-emergence herbicides need rain typically 7 to 14 days after application for optimum performance, but this timing requirement varies among herbicides.

Although grapevines have relatively good tolerance to herbicides, prevent herbicide contact with immature green bark, foliage, or fruit. While nonselective post-emergence herbicides (glyphosate, glufosinate, or paraquat) can be the most injurious, other herbicides can be phytotoxic if allowed to touch green bark or foliage. If used properly, vine shelters, homemade shields, or commercial shields for sprayers or vines can sufficiently protect vines from herbicide contact. Even with these protections in place, you should avoid spraying herbicides on windy days. Frequent mowing around the vineyard and in between the rows (alleyways for equipment passage) should be part of a vineyard manager's task list.



Figure 15. 2,4-D damage on a muscadine vine (photo by Bill Cline).

13. Insect Management

The grape root borer (*Vitacea polistiformis*) is the most significant insect pest of muscadines. If left unmanaged, grape root borer infestation can kill grape vines. Other pests include the grape flea beetle (*Altica chalybea*) and climbing cutworm (several species), which damage buds and young shoots; grape berry moth (*Paralobesia viteana*), which can feed on flowers and fruit; aphids, which can feed on young shoots; spider mites (*Tetranychus urticae* and other species), which feed on leaves; Japanese beetles (*Popillia japonica*), which feed on leaves; and green June beetles (*Cotinis nitida*), which prefer overripe fruit but can occasionally damage ripe fruit. On occasion, stink bugs can damage ripening fruit. Wasps and yellowjackets may feed on overripe and damaged fruit during harvest. Spotted wing drosophila (*Drosophila suzukii*) and African fig flies (*Zaprionus indianus*) may infest damaged fruit but are unlikely to cause direct injury. Insecticide treatment is rarely needed for pests in grapes. Consult the *Southeast Regional Muscadine Grape Integrated Management Guide* (<https://smallfruits.org/files/2019/06/Muscadine-IMG.pdf>) for season-long management recommendations.

The grape root borer (Figures 16 and 17) is native to eastern North America and is part of a family of insects known as clear-winged moths. The larva or grub tunnels through the outer bark and into the roots. Grape root borer feeding results in pruning and girdling of roots, which weakens the plant. The effect of borer feeding may not be immediately apparent. A single grape root borer larva may not cause sufficient injury to kill a plant, but plants infested with multiple grape root borer larvae or damaged over multiple years have discolored leaves, appear water stressed, are more prone to cold injury, and eventually die.

Detection. Adult grape root borer moths can be trapped with pheromone lures that are attractive to males. To maximize detection, place traps on vineyard borders and in low, poorly drained locations in the vineyard. Both sexes of moths are active during the daytime; they resemble wasps but are much slower fliers and have less rapid wing vibrations in flight. If populations are high, grape root

borer adults may be observed directly on plants. Moths are dark brown with two orange and yellow bands on the abdomen and orange colored tufts on the tips of the abdomen.

Other species of clear-wing moths, including squash vine borer moths, may also be attracted to grape root borer pheromone lures, but these moths are readily distinguishable from the grape root borer.

Grape root borer injury first appears as discolored leaves and can be confused with water stress. Dig a sample of stressed-appearing plants to examine the root system for tunnels or live root borer larvae. Mature larvae are whitish with brown heads, sparsely covered with stiff hairs, and 1¾ inches long (Figure 17). Grape root borers overwinter in the larval stage, and pupation occurs near the soil surface in June and July. The pupal stage lasts about 39 days. Shed pupal skins near the base of vines in August are also signs of infestation, but they can be difficult to detect if the vineyard floor is covered with vegetation.

Adults emerge from pupal cases at the soil line during July and August. After mating, female moths lay some 500 eggs on weeds, leaves, and bases of grape vines during their seven-day life. Grape root borer moths fly during the day, especially from noon to 4 p.m. Eggs hatch in about 15 days, and larvae develop over one to two years depending on local

temperature at a given vineyard. The grape root borer occurs on both bunch grapes and muscadines.

Management. There are three tactics for controlling grape root borer: mounding (cultural control), Lorsban (chlorpyrifos, chemical control), and Isomate GRB (mating disruption, behavioral control).

While extremely impractical, mounding soil around the bases of vines makes it more difficult for adults to emerge. After a clean cultivation, mound the soil about 1 foot tall and 1½ feet out from the base of each vine to cover the entire area around the vine base. Mounding should be done before adult emergence; appropriate timing will vary by location (for example, early to mid June for Georgia; July for North Carolina). You must knock these mounds back down between early November and late December to prevent aerial rooting of vines. Plastic mulch may also reduce the number of larvae moving into roots and adults emerging from pupae.

Pesticide treatments work by killing newly hatched larvae as they move through treated soil to roots. The only registered pesticide available for use against grape root borer is chlorpyrifos (contact insecticide), which is restricted by a 30-day preharvest interval. To determine if chlorpyrifos will be effective in an area, use pheromone traps to determine peak moth flight. If peak moth-trap captures occur 30 days before harvest, a chlorpyrifos

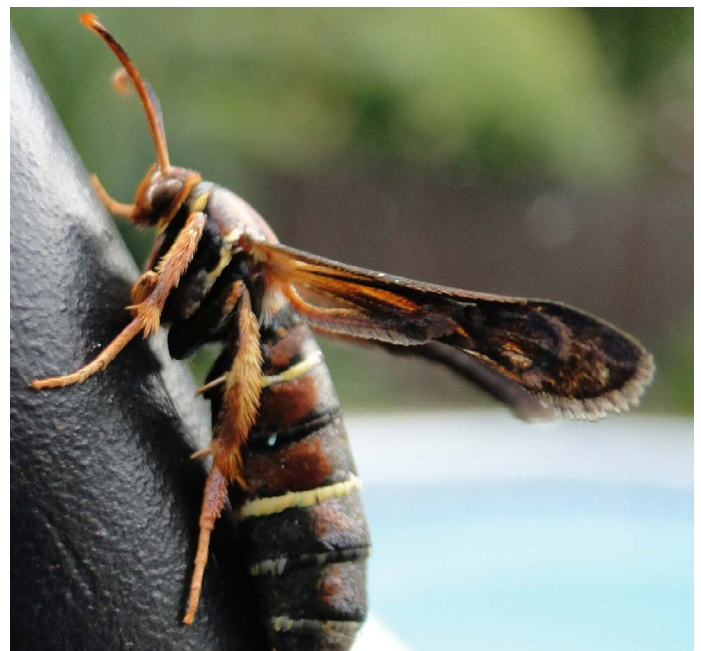

Figure 16. The grape root borer moth. Left: female and male; right: female (photos by Hannah Burrack).



Figure 17. The grape root borer. Left: Larva found in grape roots. Right: Feeding channel (photos by Mark Hoffmann).

treatment may be effective. However, if peak captures occur closer to the beginning of harvest and end before harvest, a chlorpyrifos treatment is not an option.

Mating disruption is generally the most versatile and effective method of grape root borer control, although it may be more costly and labor intensive. Pheromone dispensers shaped like twist ties are placed within vineyards at a rate of 100 per acre. You must place dispensers before peak moth flights and replace them yearly.

14. Disease Management

Muscadine leaves and grapes are less susceptible to diseases compared to many other crops. However, you may need to control fungal diseases such as angular leaf spot, bitter rot, ripe rot, macrophoma rot, and powdery mildew, which can occur frequently in muscadine vineyards. Some of those diseases can overwinter, and preventive fungicide applications help to control them. Here, we describe only a few of the most important diseases in muscadine vineyards. Consult the *Southeast Regional Muscadine Grape Integrated Management Guide* (<https://smallfruits.org/files/2019/06/Muscadine-IMG.pdf>) for recommendations on disease management throughout the season.

Angular leaf spot is an important foliar disease. Faint light-yellow spots first appear on the leaves. As the yellow spots become more noticeable, irregular brown flecks develop in the center of the spots. As the growing season progresses, the disease often increases and causes extensive defoliation by

harvest time. With heavy defoliation, the yield and quality of the grapes are reduced. Defoliation can also cause increased winter injury and introduction of other stress pathogens, such as those that cause dead-arm disease.

Bitter rot can be a very destructive fruit disease. Peak infection occurs around bloom but can continue until harvest. Just before harvest, infected grapes turn black with spore-bearing structures (acervuli) erupting through the skin of the fruit. Rotted grapes may or may not fall to the ground before harvest. The fungus infects fruit stems, leaves, and young shoots.

Powdery mildew attacks berry clusters and young grapes just after flowering. Infected grapes are covered with a white fungal growth. As the grapes enlarge, the fungal growth disappears, but the grapes become rough-skinned (russeted) and may crack and rot. Grape drop and reduced grape size occur. Powdery mildew is more prevalent in the northern range of commercial muscadines (North Carolina) and is rarely observed in Georgia or South Carolina.

Ripe rot also causes a fruit rot near harvest and can be one of the most damaging fruit rot diseases on muscadines. Rotted grapes turn dark brown over part or all of the grape and have pink or orange spore masses on the surface. Ripe rot infections can occur at any stage of fruit development, but fruit infected in the green (unripe) stages do not rot until they begin to ripen. Once infected grapes begin to rot and produce spores in the vineyard, the disease can spread rapidly to other ripe fruit. The

most devastating losses from this disease occur on susceptible cultivars during rainy harvest seasons. Generally speaking, dark-skinned cultivars are more tolerant of ripe rot, while bronze cultivars are more susceptible.

Macrophoma rot causes small, sunken, black fruit spots that are round with distinct edges in the early part of the season. As harvest approaches, these spots may develop a greasy-looking soft rot around the initial lesion. A halo develops around the black spot, and the entire fruit may rot just before harvest. Infections are sometimes not visible until the soft rot stage occurs.

Black rot causes a circular brown leaf spot and a black scab on grapes. Occasionally, lesions occur on the young stems and tendrils.

Pierce's disease is a bacterial pathogen of little importance on most muscadine grapes, but occasionally can cause a marginal leaf burn. Growers should avoid propagating from symptomatic vines. Vector management of the sharpshooter insects that transmit the pathogen is not recommended for muscadines, as the disease is generally not significant enough to warrant use. Chemical control is not available. Most cultivars are relatively resistant to Pierce's disease, though some are susceptible (including Carlos and Noble); we recommend avoiding cultivars that suffer from Pierce's disease.

Crown gall is mainly associated with physical damage (such as from weed string trimmers or wire rubs) or freezing weather. Crown gall is generally not significant where winter temperatures are mild. Crown gall is caused by a bacterium (*Agrobacterium vitis*) frequently associated with gall formation on grape vines. Galls are fleshy, irregularly shaped growths. Galls will form along the length of the trunk and cordons. Avoid planting in fall, when plants are exposed to freeze injury. The crown gall bacterium can enter the vineyard site along with propagated plants, though indexed (crown-gall-tested and gall-free) plants may be available from nurseries. Purchase plants from reputable nurseries (see Chapter 17) with a history of providing disease-free plants.

Generally, cultural practices, site location, and cultivar selection are imperative for an effective disease management program. You can avoid freeze injuries by choosing a suitable combination of site and cultivar (Table 2). Proper pruning and frequent retraining of cordons, especially when winter damage has occurred, reduces the amount of dead-arm disease (Figure 18). Bronze cultivars such as Fry are more susceptible to ripe rot than dark-skinned cultivars. Cultural practices can reduce the disease pressure in a vineyard. For example, mowing and reducing canopy undergrowth will improve air movement through the vineyard. Timely harvesting, removal of leftover fruit, and abstaining from late-season fertilizing will also help reduce disease incidence. A regular spray program with effective fungicides is highly beneficial and profitable. An effective disease control program is essential to producing economical crop yields of quality grapes with the newer cultivars. In new vineyards, the disease control program should begin in the second or third season after planting. Repeated early-season applications of fungicides are most effective at managing many of the pervasive fungal diseases discussed here.



Figure 18. "Dead-arm" disease is caused by multiple fungal woodborne pathogens due to cold injury and pruning. Frequently replace cordons that show die-back and dead-arm symptoms (photo by Mark Hoffmann).

Table 6. Fungicide efficacy against diseases of muscadine grapes

Efficacy of selected fungicides against diseases of muscadine grape ¹											
Fungicide	PHI (Pre-Harvest Interval)	Mode-of-Action (MOA) Grouping ²	FRAC code ³	Bitter rot	Powdery mildew	Ripe rot	Macro-phoma rot	Black rot	Sooty blotch	Dead arm	Angular leaf spot
Myclobutanil (Rally)	14 days	G	3	++ ²	++++	NA	+	++++	+++	???	++++
Thiophanate-methyl (Topsin- M)	7 days	B	1	++	+++	+	+	+++	+++	++	+++
Wettable Sulfur (Microthiol and other trade names)	1 day (re-entry)	Multi-site	M 2	NA	++++	NA	NA	NA	???	NA	NA
Pyraclostrobin + boscalid (Pristine)	14 days	C	7+11	+++	++++	++++	+++++	++++	+++++	++	++++
Kresoxim-methyl (Sovran)	14 days	C	11	+++	+++	+++	++	+++	+++	++	+++
Azoxystrobin (Abound)	14 days	C	11	+++	++++	++++	++++	++++	++++	++	++++
Trifloxystrobin (Flint)	14 days	C	11	+++	++++	++++	+++++	++++	+++++	++	+++
Ziram (Ziram)	21 days	Multi-site	M 3	++	++	+++	++	+++	+++	++	+++
Captan (Captan, Captec)	0 days (72 hrs re-entry)	Multi-site	M 4	++	++	++++	+++	+++	+++	++	+++
EBDCs (includes Maneb, Manex, Penncozeb, Manzate, Dithane M-45)	66 days	Multi-site	M 3	+++	++	NA	++	+++	++	++	+++

¹ NA = no significant activity, ??? = unknown activity; + = very limited activity, ++ = limited activity, +++ = moderate activity, ++++ = good activity, ++++ = excellent activity.

² Alternation of fungicides with different modes of action helps prevent the development of pest resistance to a particular class of fungicide. There is no benefit to alternating or tank-mixing fungicides with the same mode of action. Fungicides listed as "multi-site" are the least likely to be overcome by a resistant strain of a pathogen.

³ In addition to MOA grouping, the FRAC code also indicates fungicides that can be alternated to discourage pest resistance; alternate or tank-mix only those products having different FRAC codes.

15. Harvesting

Depending on location and cultivar, muscadine harvest begins in August and continues through October and sometimes into early November. Generally, the fruit is picked over several harvests for fresh marketing and in one harvest for processing.

Mechanized harvest: Mechanical harvesters permit a one-pass harvest for grapes to be processed, working at the rate of 1 acre per hour. Mechanical harvesters are very expensive; we advise growers to have their wine grapes custom-harvested. Bulk bins handled with forklifts are used with harvesters, completing the mechanization process. Catch-frame harvesting is used where custom harvesting

services are unavailable and the vineyard is too small to justify an investment

in a mechanical harvester. Catch-frames fit under vines and collect berries as they fall. You usually shake berries from the vine by striking the trellis with a padded club. The catch-frame then funnels the berries into suitably sized containers, usually perforated plastic bins. Catch-frame harvesting requires three to five people for maximum efficiency; the average time to harvest one vine is three to seven minutes.

Fresh fruit: Carefully hand-pick fruit for fresh-market sales. Some cultivars (Fry, Magnolia) tear when

pulled from the cluster and have wet stem scars. Consult U.S. Department of Agriculture grading standards for fresh bronze or dark muscadine cultivars (<https://www.ams.usda.gov/grades-standards/muscadine-grapes-grades-and-standards>). To prolong shelf life, use plastic clamshells (plastic boxes with holes for ventilation) and store grapes near 34°F until the fruit is sold.

Customer harvest ("U-Pick"): Some growers have had success with growing muscadines for customer harvest. Successful U-Pick operations are located near population centers. It is best to start a U-Pick vineyard on a small scale and expand as demand for fruit increases. Pre-picking fruit for sale at the vineyard, farm markets, and satellite stands is becoming increasingly important as fewer people are interested in picking their own. Larger grapes like Triumph, Nesbitt, and Supreme are popular for direct marketing.

16. Muscadine Fruit Quality and Food Safety

Fresh-market muscadines differ considerably from those grown for processing. Fresh-market muscadines need to be large (over 6 g per berry or <50 berries per quart), have a dry stem scar or a wet scar that will dry quickly, and have a storage life greater than 14 days. Stem scar is the primary entry point for decay, so it is important that the scar does not tear during harvest or ooze juice. Size, color, color uniformity, and lack of cosmetic defects and blemishes are also important in cultivar selection. Bronze and dark colors are the most well recognized. Pink or red muscadines are often less favored because some bronze types can turn pink with age, and some of the older red cultivars can show aging more than new cultivars. Some bronze cultivars, such as Granny Val, tend to remain green even when fully ripe; this trait suggests that the fruit is less sweet. The soluble solids content or °Brix should be >14. More subtle characteristics for a good fresh-market muscadine include skin toughness and flesh type. A thinner skin, ease of chewing, a nonslip skin character, and a crisp flesh are preferred for fresh eating. Smaller muscadines that have a wet stem scar, like Carlos, are best used for processing. Carlos is highly productive and a good juice yielder. In

contrast, several of the firmer-fleshed fresh-market cultivars will yield less juice. Nesbitt, although a smaller muscadine, is used for both fresh market and processing.

Food Safety

Every year, thousands of people in the United States become severely ill due to the consumption of contaminated or underprocessed food products. Obeying food safety and product quality standards is critical for both fresh-market muscadine farmers and muscadine processors (jam, jelly, juice, wine). The Food Safety Modernization Act (FSMA) of 2011 established minimum standards for the growing, harvesting, packing, and holding of fruits and vegetables in the United States. Generally, a muscadine farm or a farm mixed-type facility is subject to FSMA regulation if the average annual monetary value of sold muscadines is more than \$25,000. Certain circumstances can exempt a farm from some or all regulations but only if the average annual monetary value of all food sold over the past three-year period was less than \$500,000. Contact your state's department of agriculture to learn more about the specifics. The state of North Carolina developed an On-Farm Readiness Review program (OFRR), which is a voluntary nonregulatory review of a farm's readiness for food safety compliance (see Chapter 17).

We highly recommend that you obey certain common sense food safety practices even if you are below the \$25,000 threshold or your farm is exempt from FSMA regulations: (1) *Animal control:* Don't allow domesticated or wild animals in any vineyard at any time of the year, especially during harvest time. Animals can carry diseases, and protection (for example, fences or nets) is recommended if wildlife numbers are high. (2) *Sanitation:* Provide sanitary facilities and hand-washing stations to all pick-your-own customers and harvesting crew. Make sure that crew members wear clean, sterile rubber gloves when picking fruit. In pick-your-own operations, encourage your customers to wash their hands before they start picking fruit. (3) *Pesticide Residues:* A vineyard should be opened for harvest only when pesticide pre-harvest intervals (PHI) are met. If a pesticide has a PHI of 66 days, fruit may not be consumed until the 67th day after the pesticide

application — this is required even if no fruit is present at the time of the pesticide application. We highly recommend checking the PHI of every chemical product before using it in a vineyard. Wholesalers and retailers often have more strict food safety and food quality standards than those required by FSMA.

Juice and Wine Quality

Juice and wine quality standards are not enforced by law. However, the expanding North Carolina grape and wine industry has developed a volunteer, nonbinding quality standard program for the Southeast: the North Carolina Quality Alliance Program (QAP). The QAP is a joint effort between

the N.C. Winegrower’s Association and Surry Community College. It is a fee-driven program to evaluate juice and wine samples on the chemical integrity and quality parameters of a cultivar. The program provides free QAP labels if samples are within industry quality standards, and also gives feedback to juice and winemakers if defects are recognized (see Chapter 17). Although the QAP is not a federal or state requirement, we recommend that all wine and juice making facilities in the Southeast join the QAP to enhance the overall quality of wine and juice products in the Southeast. To sign up for the QAP program, contact the N.C. Winegrower’s Association (see Chapter 17).

17. Resources

Agronomic Field Services: NCDA&CS:

www.ncagr.gov/agronomi/rahome.htm

Extension: Clemson Cooperative Extension:

www.clemson.edu/extension

Extension: NC State Extension: www.ces.ncsu.edu

Extension: NC A&T Cooperative Extension:

www.ncat.edu/caes/cooperative-extension

Extension: University of Georgia Cooperative

Extension: extension.uga.edu

Fayetteville Tech Community College:

www.faytechcc.edu

French Broad Vignerons (Western North Carolina):

frenchbroadvignerons.org

NC Muscadine Grape Association:

www.northcarolinamuscadinegrapeassociation.org

NC Winegrower's Association:

www.ncwinegrowers.com/index.php

NCDA&CS soil and plant tissue analytic lab:

www.ncagr.gov/agronomi/mission.htm

NCDA&CS FSMA: [www.ncagr.gov/fooddrug/food/](http://www.ncagr.gov/fooddrug/food/ProduceSafetyProgram.htm)

[ProduceSafetyProgram.htm](http://www.ncagr.gov/fooddrug/food/ProduceSafetyProgram.htm)

NCSU Muscadine Grape Portal:

grapes.ces.ncsu.edu

Frequent updates on muscadine production issues in North Carolina.

NCSU Plant Disease and Insect Clinic:

projects.ncsu.edu/cals/plantpath/extension/clinic

North Carolina Winegrape Grower's Guide:

content.ces.ncsu.edu/north-carolina-winegrape-growers-guide

North Carolina Agricultural Chemicals Manual:

content.ces.ncsu.edu/north-carolina-agricultural-chemicals-manual

Nursery: Bottom's Nursery:

www.bottomsnursery.com/

Nursery: Ison's Nursery & Vineyards:

www.isons.com

Nursery: Starks Bro's: www.starkbros.com/

Nursery: Willis Orchard Co.:

www.willisorchards.com

Nursery: Woodard's Farm & Nursery:

www.woodardsfarmandnursery.com

Quality Alliance Program:

www.ncwinegrowers.com/quality_alliance.php

Southern Region Small Fruit Consortium:

Southeast Regional Muscadine Grape Integrated Management Guide

smallfruits.org/files/2019/06/Muscadine-IMG.pdf

Yearly updated resource on Integrated Pest Management Practices for muscadine vineyards.

Southern Region Small Fruit Consortium: SFRC-

2012-E03 Marketing guide for fresh market muscadine grapes.

smallfruits.org/files/2019/06/2012-E03.pdf

Surry Community College NC Viticulture Center:

ncviticulturecenter.surry.edu

UGA Agriculture and Environmental Services

Laboratories: aesl.ces.uga.edu

UGA Extension Viticulture Blog:

site.extension.uga.edu/viticulture

Provides timely management updates and reminders and announces statewide and regional grape-related workshops and conferences.

UGA Muscadine Grape Breeding Website:

muscadines.caes.uga.edu. Pictures and reviews of most common muscadine cultivars.

USDA-NRCS, Natural Resources Conservation

Service

www.nrcs.usda.gov/wps/portal/nrcs/site/national/home

18. Literature

- Anderson, L. J., L. H. Comas, A. N. Lakso, D. M. Eissenstat. 2003. "Multiple risk factors in root survivorship: a 4-year study in Concord grape." *New Phytologist* 158, no. 3 (June): 489-501. doi.org/10.1046/j.1469-8137.2003.00757.x.
- Attaway, J. E. *Hurricanes and Florida Agriculture*. 1999. Lake Alfred, FL: Florida Science Source.
- Brown, K., C. Sims, A. Odabasi, L. Bartoshuk, P. Conner, and D. Gray. 2016. "Consumer acceptability of fresh market muscadine grapes." *Journal of Food Science* 11, no. 81 (November): S2808-S2816.
- Comas, L. H., D. N. Eissenstat, and A. N. Lakso. 2000. "Assessing root death and root system dynamics in a study of grape canopy pruning." *New Phytologist* 147, no. 1 (July): 171-178.
- Eissenstat, D. M. and R. D. Yanai. 1997. "The ecology of root lifespan." *Advances in Ecological Research* 27 (December): 1-60.
- Fisk, C., Bloodworth, B., Cline, B. and Jones, W. 2008. *Propagating Muscadine Grapes*. AG-698W. Raleigh, NC: NC State Extension. <https://content.ces.ncsu.edu/propagating-muscadine-grapes>
- Kottek, M., J. Grieser, C. Beck, B. Rudolf, and F. Rubel. 2006. "World map of the Koeppen-Geiger climate classification updated." *Meteorologische Zeitschrift* 15, no. 3: 259-263.
- McCormack, M. L. and D. Guo. 2014. "Impacts of environmental factors on fine root lifespan." *Frontiers in Plant Science* 5 (May): 205. doi 10.3389/fpls.2014.00205.
- Munoz-Rodriguez, A. F., M. I. Silva, and R. Tormo-Molina. 2011. "Pollination dynamics in *Vitis vinifera* L." *American Journal of Enology and Viticulture* 62, no. 1 (March): 113-117.
- Poling, E. B., C. M. Mainland, W. T. Bland, B. Cline, and K. A. Sorensen. 2003. *Muscadine Grape Production Guide for North Carolina*. AG-94. Raleigh, NC: NC State Extension. <https://content.ces.ncsu.edu/muscadine-grape-production-guide>
- Poling, E. B. and S. Spayd. 2015. *The North Carolina Winegrape Grower's Guide*. Raleigh, NC: NC State Extension. <https://content.ces.ncsu.edu/north-carolina-winegrape-growers-guide>
- Poling, E. B. 2016. *A Step-by-Step Approach to Pruning Carlos Muscadine Grapevines*. AG-776. Raleigh, NC: NC State Extension. <https://content.ces.ncsu.edu/north-carolina-winegrape-growers-guide>
- Terando, A., L. Cater, K. Dow, K. Hiers, K. E. Kunkel, A. Lascurain, D. Marcy, M. Osland, P. Schramm, and A. Jerolleman. 2018. "Southeast" in *Fourth National Climate Assessment, V. 2* Washington, DC: U.S. Global Change Research Program. <https://nca2018.globalchange.gov/chapter/19/>.
- Sampson, B., S. Noffsinger, C. Gupton, and J. Magee. 2001. "Pollination biology of the muscadine grape." *HortScience* 36, no.1 (February): 120-124.
- Wan, Y., H. R. Schwaninger, A. M. Baldo, J. A. Labate, G. Zhong, and C. J. Simon. 2013. "A phylogenetic analysis of the grape genus (*Vitis* L.) reveals broad reticulation and concurrent diversification during neogene and quaternary climate change." *BMC Evolutionary Biology* 13 (July): 141.

Acknowledgments

We want to thank Erick Smith from University of Georgia, Terry Bland from North Carolina State University, and Connie Fisk from Cornell University for their help editing this production guide. We also want to thank Debby Wechsler, the secretary of the North Carolina Muscadine Grape Association, for her help and critical editing of the manuscript. The Southern Region Small Fruit Consortium funded the development of this document.



College of Agriculture
and Life Sciences

Recommendations for the use of agricultural chemicals are included in this publication as a convenience to the reader. The use of brand names and any mention or listing of commercial products or services in this publication does not imply endorsement by NC State University or N.C. A&T State University nor discrimination against similar products or services not mentioned. Individuals who use agricultural chemicals are responsible for ensuring that the intended use complies with current regulations and conforms to the product label. Be sure to obtain current information about usage regulations and examine a current product label before applying any chemical. For assistance, contact your local N.C. Cooperative Extension county center.

Distributed in furtherance of the acts of Congress of May 8 and June 30, 1914. North Carolina State University and North Carolina A&T State University commit themselves to positive action to secure equal opportunity regardless of race, color, creed, national origin, religion, sex, age, veteran status, or disability. In addition, the two Universities welcome all persons without regard to sexual orientation. North Carolina State University, North Carolina A&T State University, U.S. Department of Agriculture, and local governments cooperating.

01/20—CB/DI

content.ces.ncsu.edu/muscadine-grape-production-guide

© 2020 North Carolina State University

copies of this publication were printed at a cost of \$### or \$## per copy.

AG-94

